

Advance Computer Networks

#2 Routing Algorithm 😊

Semester Ganjil 2012

PTIIK – Universitas Brawijaya

Today's Lecture

- This Course
 - Goals :
 - Understanding & Implementing Simple Inter AS Routing
 - Understanding Intra AS routing
- RIP
- OSPF
- BGP

References

- Kurose & Ross, “Computer Networking : Top down Approach”, 6th Ed., Pearson/Addison, 2012.
- Chapter 4
 - Network Layer

#3 – Routing Protocols

RIP

OSPF

BGP

Intra-AS Routing

- also known as *interior gateway protocols (IGP)*
- most common intra-AS routing protocols:
 - RIP: Routing Information Protocol
 - OSPF: Open Shortest Path First
 - IGRP: Interior Gateway Routing Protocol (Cisco proprietary)

RIP (Routing Information Protocol)

- included in BSD-UNIX distribution in 1982
- distance vector algorithm
 - distance metric: # hops (max = 15 hops), each link has cost 1
 - DVs exchanged with neighbors every 30 sec in response message (aka **advertisement**)
 - each advertisement: list of up to 25 destination **subnets** (in IP addressing sense)

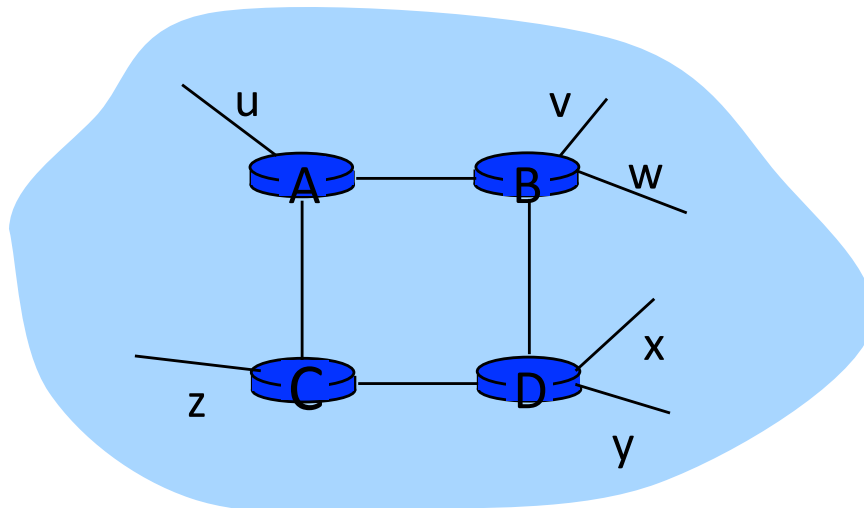

from router A to destination **subnets**:

<u>subnet</u>	<u>hops</u>
u	1
v	2
w	2
x	3
y	3
z	2

RIP: example

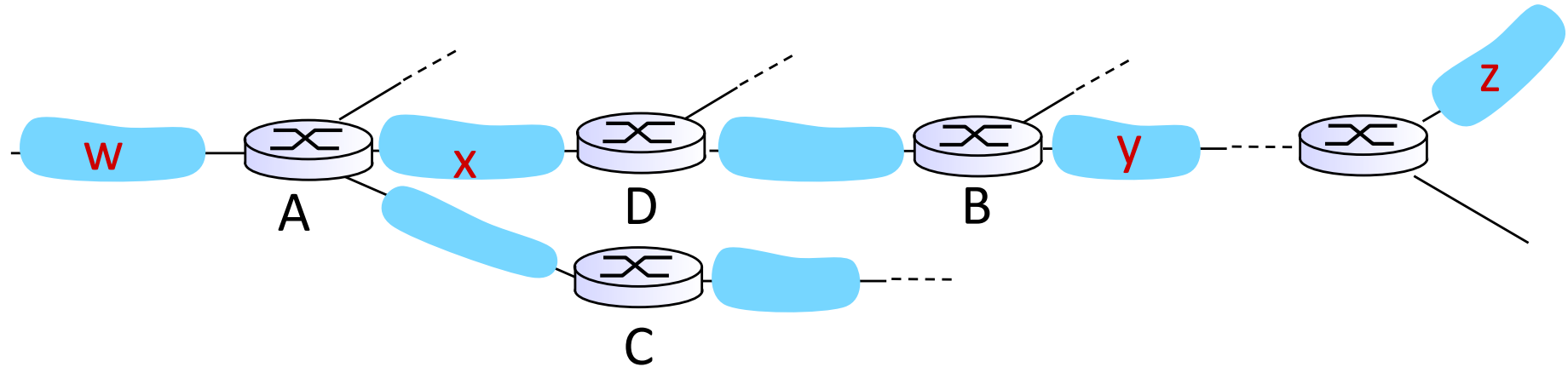

routing table in router D

Destination subnet	next router	# hops to dest
W	A	2
Y	B	2
Z	B	7
X	--	1
....

Network Layer

RIP: example

A-to-D advertisement

dest	next hops
W	- 1
X	- 1
Z	C 4
....

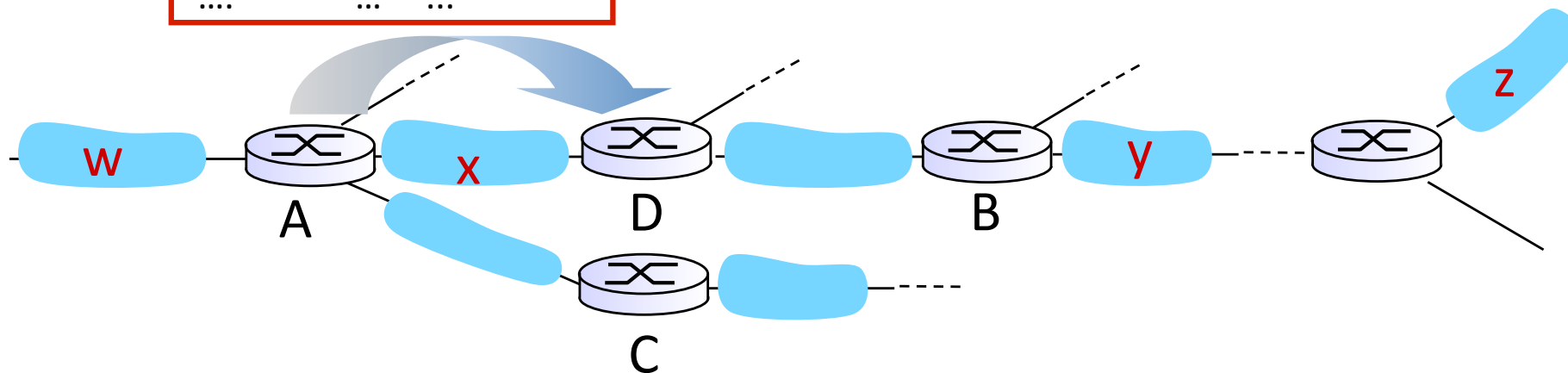

routing table in router D

destination subnet	next router	# hops to dest
W	A	2
Y	B	2
Z	B A	7 5
X	--	1
....

Network Layer

RIP: link failure, recovery

if no advertisement heard after 180 sec -->
neighbor/link declared dead

- routes via neighbor invalidated
- new advertisements sent to neighbors
- neighbors in turn send out new advertisements (if tables changed)
- link failure info quickly (?) propagates to entire net
- *poison reverse* used to prevent ping-pong loops (infinite distance = 16 hops)

RIP table processing

- RIP routing tables managed by *application-level* process called route-d (daemon)
- advertisements sent in UDP packets, periodically repeated

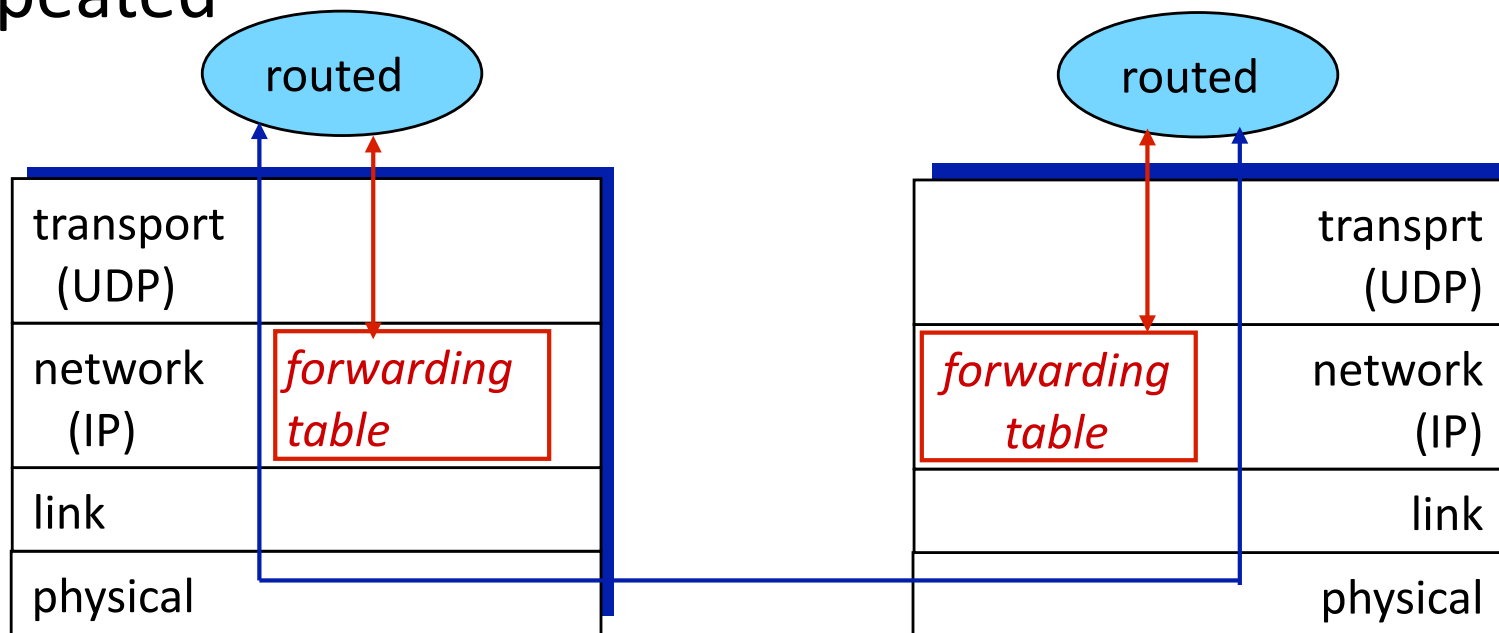

OSPF (Open Shortest Path First)

- “open”: publicly available
- uses link state algorithm
 - LS packet dissemination
 - topology map at each node
 - route computation using Dijkstra’s algorithm
- OSPF advertisement carries one entry per neighbor
- advertisements flooded to *entire* AS
 - carried in OSPF messages directly over IP (rather than TCP or UDP)
- *IS-IS routing* protocol: nearly identical to OSPF

OSPF “advanced” features (not in RIP)

- *security*: all OSPF messages authenticated (to prevent malicious intrusion)
- **multiple** same-cost **paths** allowed (only one path in RIP)
- for each link, multiple cost metrics for different **TOS** (e.g., satellite link cost set “low” for best effort ToS; high for real time ToS)
- integrated uni- and **multicast** support:
 - Multicast OSPF (MOSPF) uses same topology data base as OSPF
- **hierarchical** OSPF in large domains.

Hierarchical OSPF

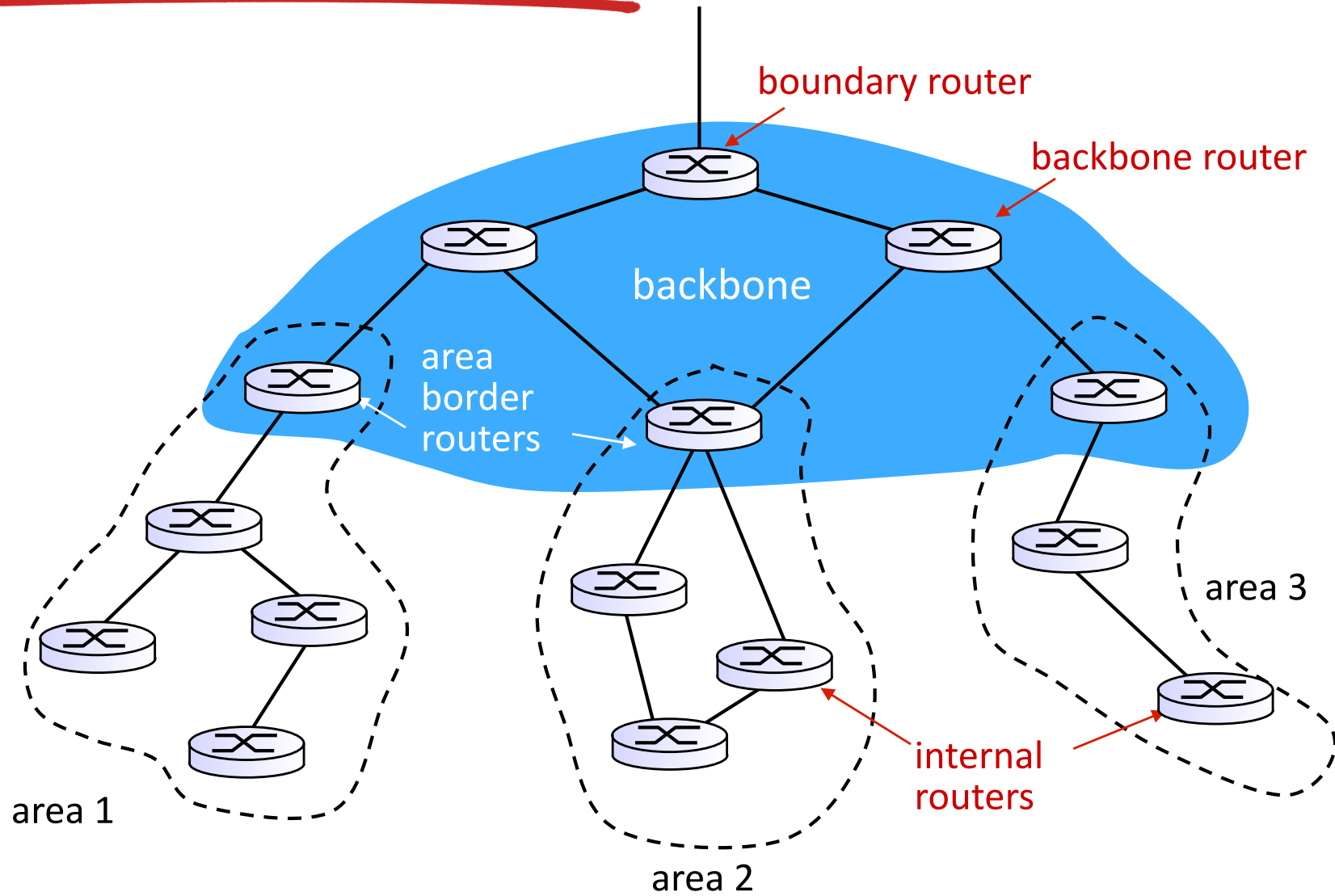

Hierarchical OSPF

- *two-level hierarchy*: local area, backbone.
 - link-state advertisements only in area
 - each nodes has detailed area topology; only know direction (shortest path) to nets in other areas.
- *area border routers*: “summarize” distances to nets in own area, advertise to other Area Border routers.
- *backbone routers*: run OSPF routing limited to backbone.
- *boundary routers*: connect to other AS’ s.

Internet inter-AS routing: BGP

- **BGP (Border Gateway Protocol):** *the* de facto inter-domain routing protocol
 - “glue that holds the Internet together”
- BGP provides each AS a means to:
 - **eBGP:** obtain subnet reachability information from neighboring ASs.
 - **iBGP:** propagate reachability information to all AS-internal routers.
 - determine “good” routes to other networks based on reachability information and policy.
- allows subnet to advertise its existence to rest of Internet:
“I am here”

AS46019 IPv4 Route Propagation

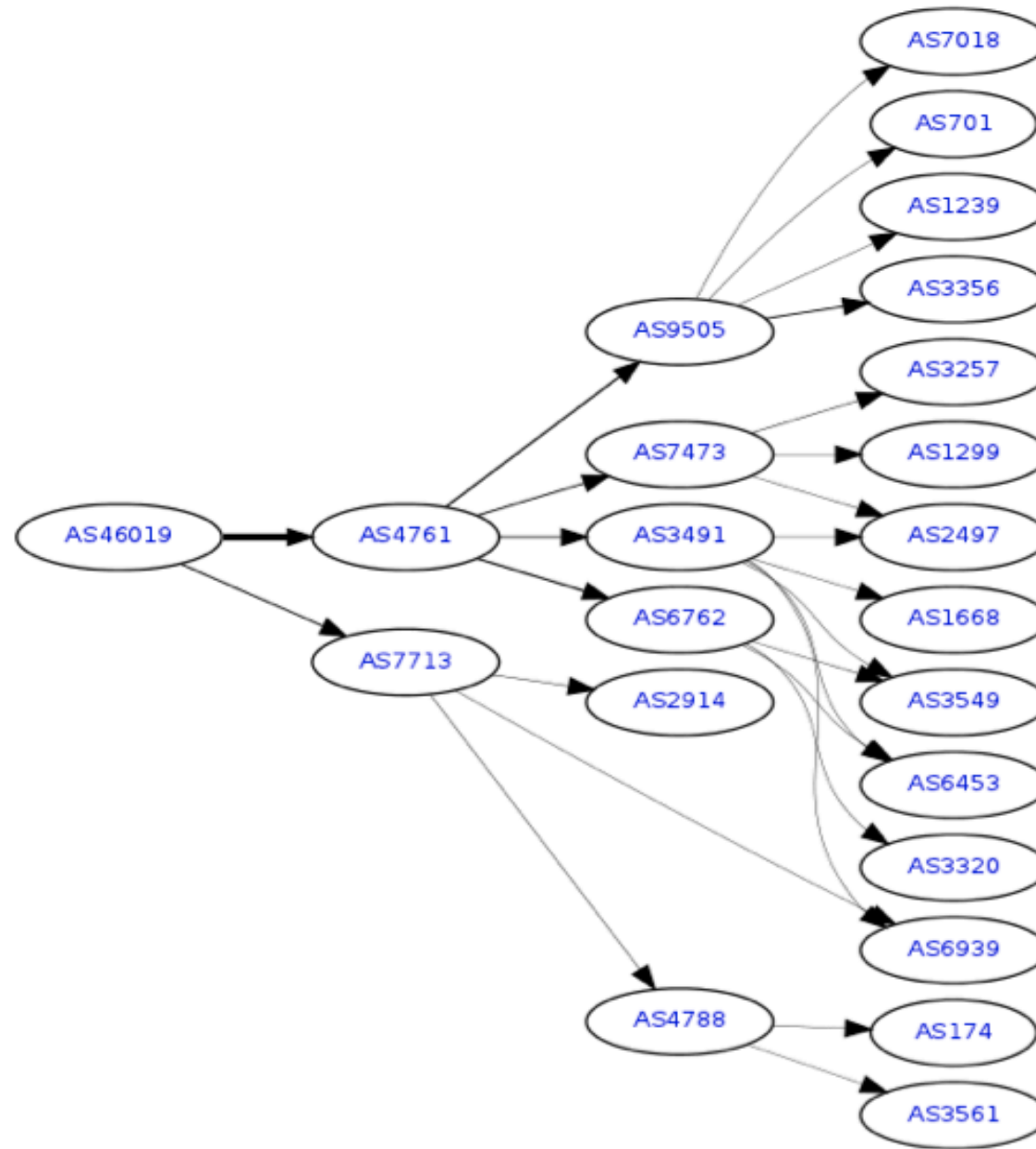

BGP basics

- ❖ **BGP session:** two BGP routers (“peers”) exchange BGP messages:
 - advertising *paths* to different destination network prefixes (“path vector” protocol)
 - exchanged over semi-permanent TCP connections
- when AS3 advertises a prefix to AS1:
 - AS3 *promises* it will forward datagrams towards that prefix
 - AS3 can aggregate prefixes in its advertisement

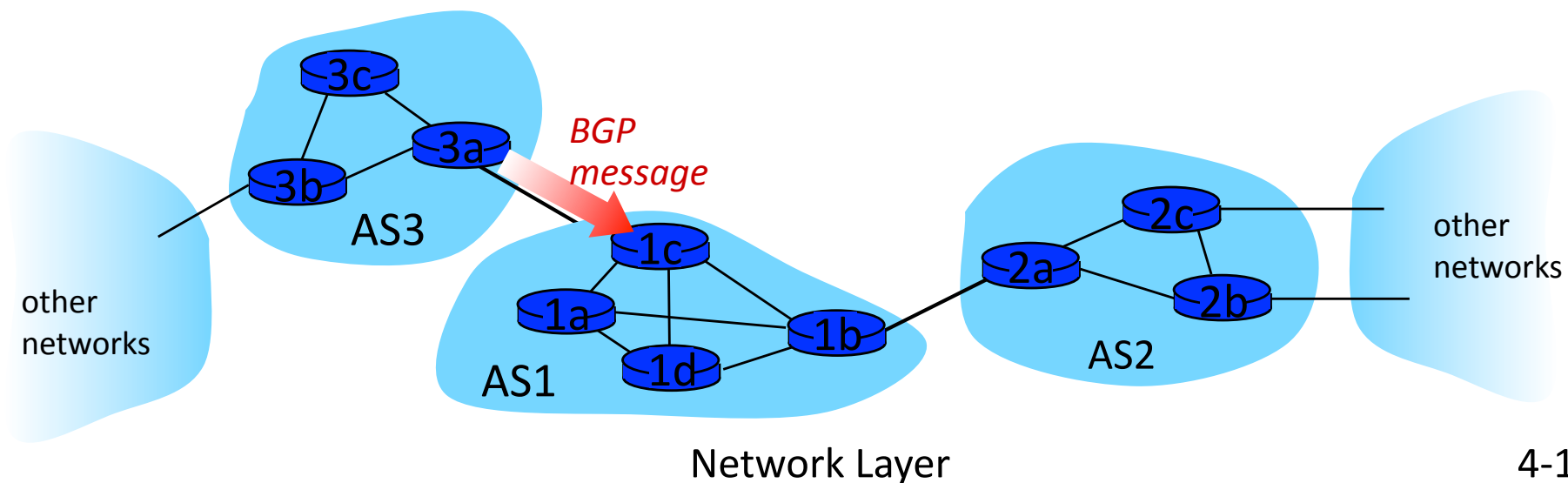

BGP basics: distributing path information

- using eBGP session between 3a and 1c, AS3 sends prefix reachability info to AS1.
 - 1c can then use iBGP to distribute new prefix info to all routers in AS1
 - 1b can then re-advertise new reachability info to AS2 over 1b-to-2a eBGP session
- when router learns of new prefix, it creates entry for prefix in its forwarding table.

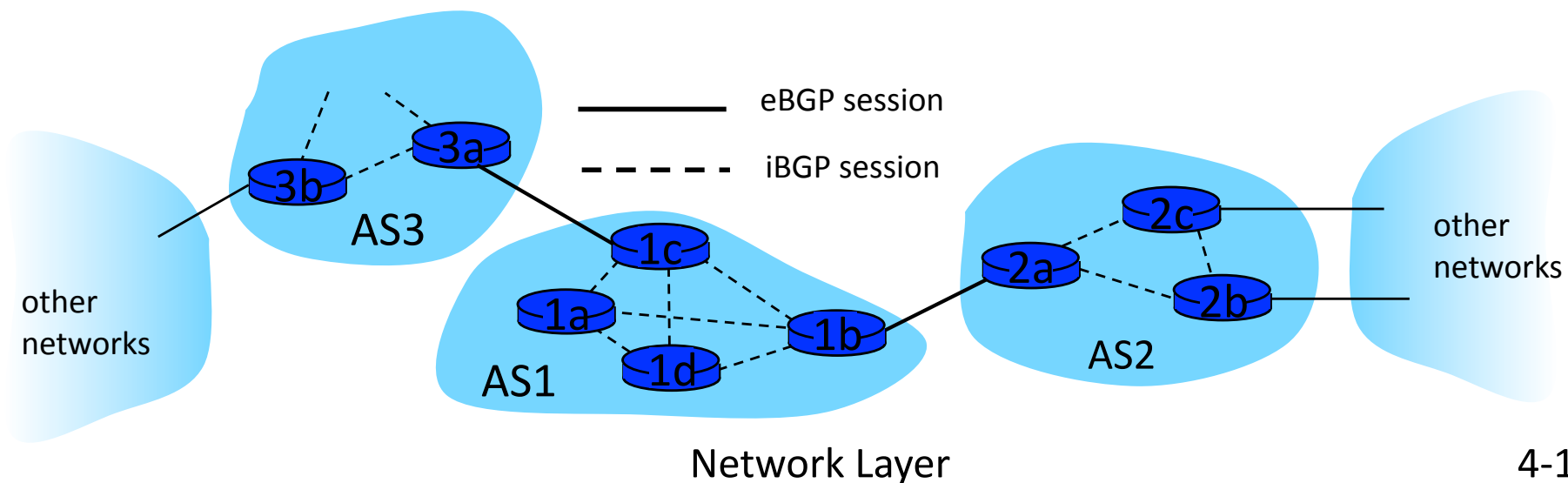

Path attributes and BGP routes

- advertised prefix includes BGP attributes
 - prefix + attributes = “route”
- two important attributes:
 - **AS-PATH**: contains ASs through which prefix advertisement has passed: e.g., AS 67, AS 17
 - **NEXT-HOP**: indicates specific internal-AS router to next-hop AS. (may be multiple links from current AS to next-hop-AS)
- gateway router receiving route advertisement uses **import policy** to accept/decline
 - e.g., never route through AS x
 - *policy-based* routing

BGP route selection

- router may learn about more than 1 route to destination AS, selects route based on:
 1. local preference value attribute: policy decision
 2. shortest AS-PATH
 3. closest NEXT-HOP router: hot potato routing
 4. additional criteria

BGP messages

- BGP messages exchanged between peers over TCP connection
- BGP messages:
 - **OPEN**: opens TCP connection to peer and authenticates sender
 - **UPDATE**: advertises new path (or withdraws old)
 - **KEEPALIVE**: keeps connection alive in absence of UPDATES; also ACKs OPEN request
 - **NOTIFICATION**: reports errors in previous msg; also used to close connection

BGP routing policy

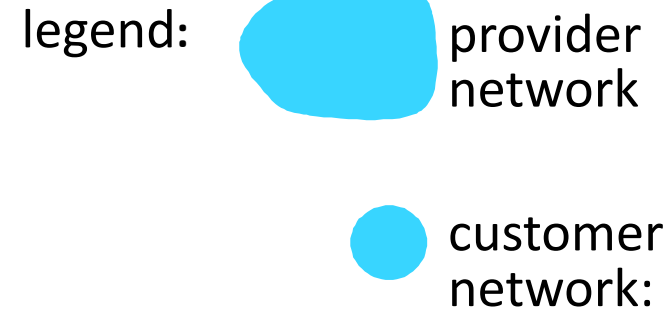
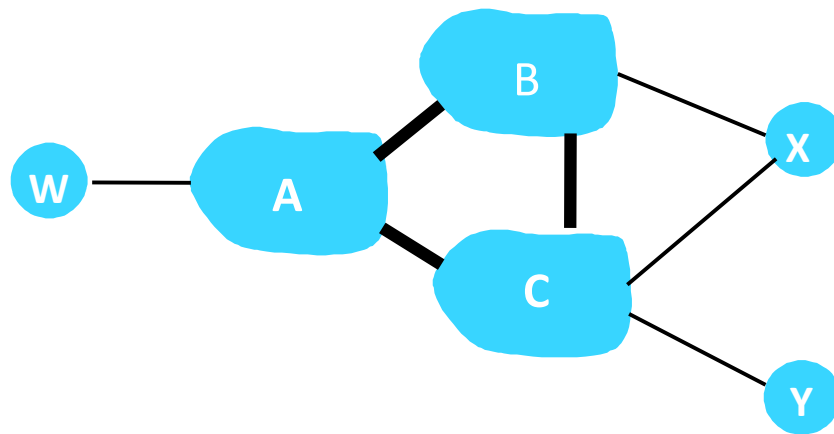

- ❖ A,B,C are *provider networks*
- ❖ X,W,Y are customer (of provider networks)
- ❖ X is *dual-homed*: attached to two networks
 - X does not want to route from B via X to C
 - .. so X will not advertise to B a route to C

BGP routing policy (2)

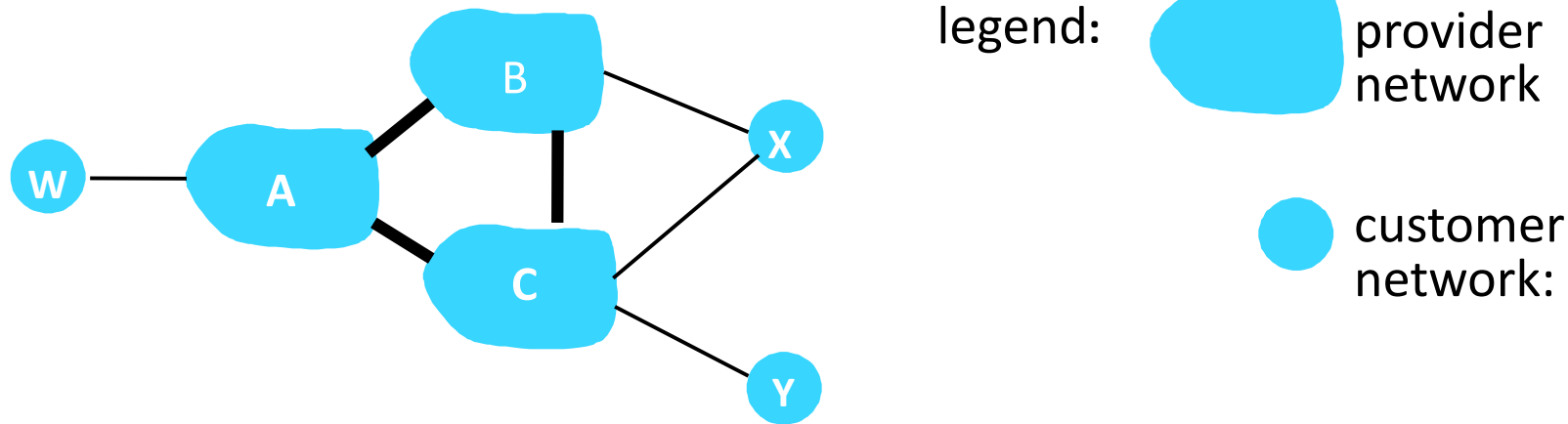

- ❖ A advertises path *AW* to B
- ❖ B advertises path *BAW* to X
- ❖ Should B advertise path *BAW* to C?
 - No way! B gets no “revenue” for routing *CBAW* since neither W nor C are B’s customers
 - B wants to force C to route to w via A
 - B wants to route *only* to/from its customers!

Why different Intra-, Inter-AS routing ?

policy:

- inter-AS: admin wants control over how its traffic routed, who routes through its net.
- intra-AS: single admin, so no policy decisions needed

scale:

- hierarchical routing saves table size, reduced update traffic

performance:

- intra-AS: can focus on performance
- inter-AS: policy may dominate over performance